

Laserové vyrezávanie FAD STU

Rozmer rezania Dimension of laser cutting

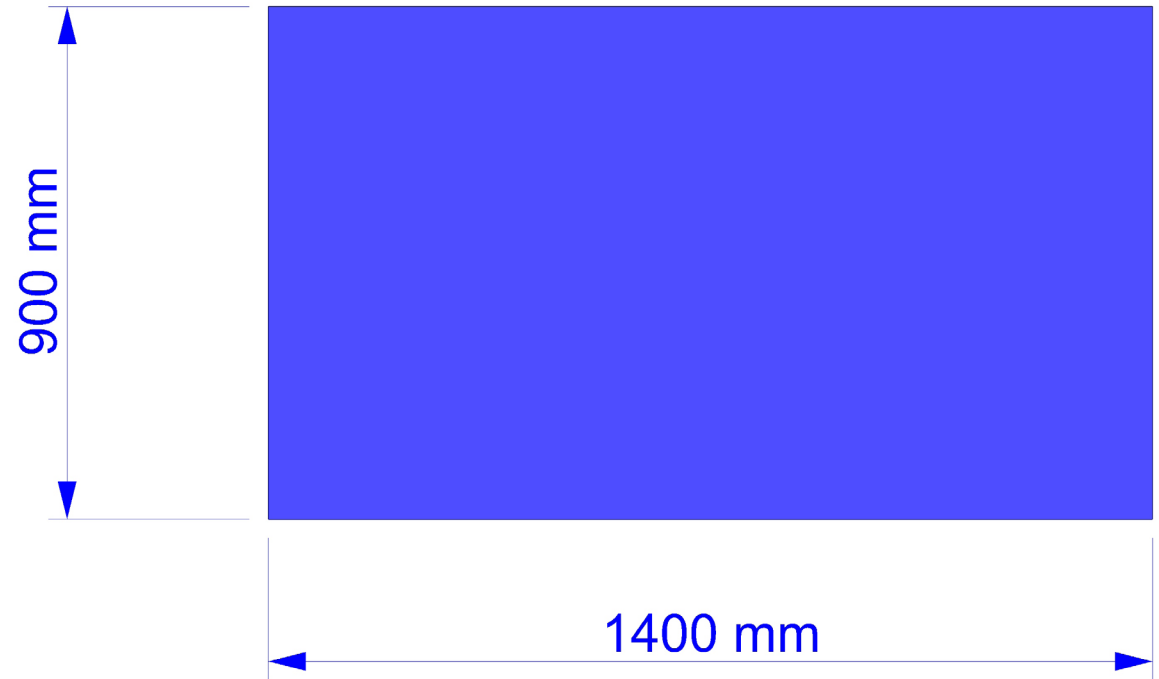
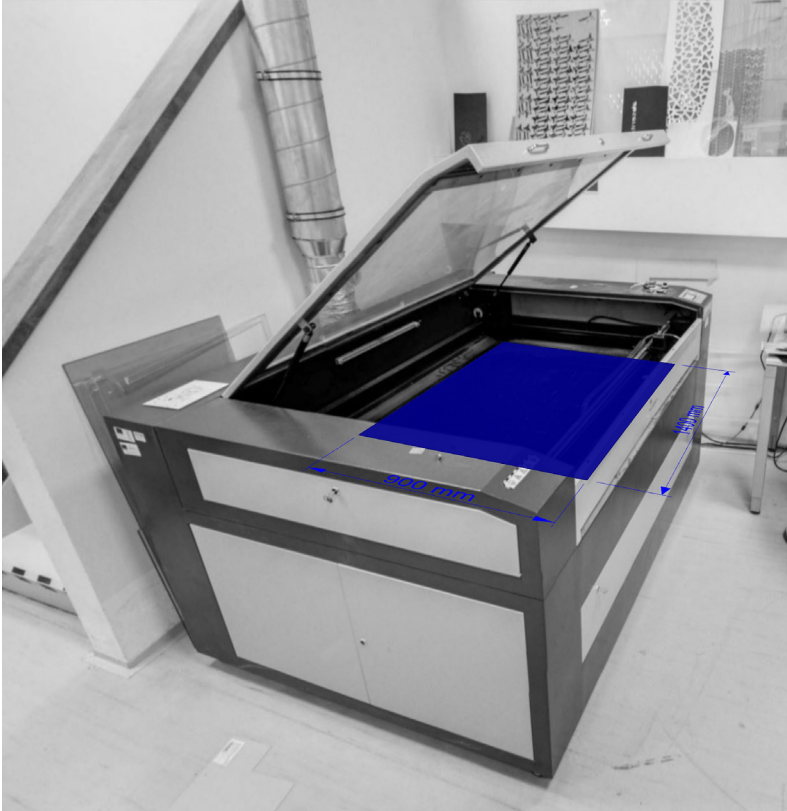

Maximálny rozmer rezania u nás je 900x1400 mm.
Maximum dimensions for lasercut are 900x1400 mm.

Material Material

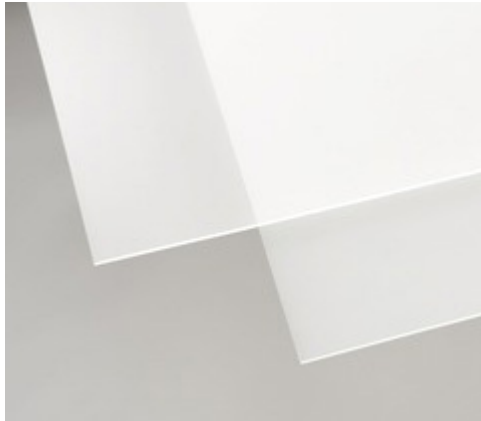

Maslový kartón - maslák (napr. STISO), Plexisklo - akryl napr. <http://www.island.sk/>, Dyha, Preglejka
Iné materiály po konzultácií. Určite nie HPS, Komatex, Hliník !!!

Cardboards (e.g. from STISO), Plexiglass - acrylic e.g. <http://www.island.sk/>, Veneer, Plywood
Other materials after consultation. Definitely no for HPS plastics, Komatex plastics, Metal !!!

Formát dát Data format

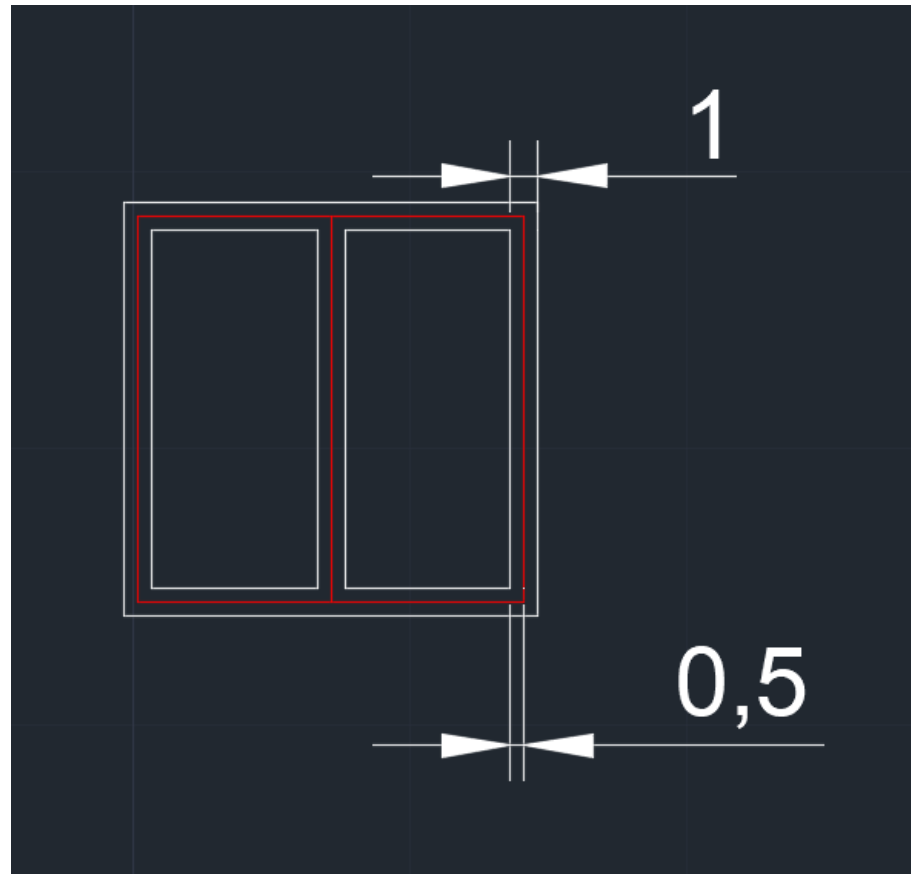

Formát dát by mal byť 2D linky alebo polyliny v [.dxf](#)

Príklad okna pre rezanie v 1:100. Biela - rezanie, červená - gravírovanie. Linky rezu by mali byť vzdialené min. 1 mm. Linky rezu a gravírovania by mali byť vzdialené min. 0,5 mm. Viete ísť aj bližšie, ale riskujete prekryv - zliatie línií.

Data format should be 2D lines or polylines in [.dxf](#)

Example of window for lasercut in 1:100. White - cut, red - engrave. Gaps between cutting lines should be min. 1 mm. Gaps between engraving and cutting lines should be min. 0.5 mm. You can go even closer but the lines would overlay.

Formát dát - AutoCAD

Data format - AutoCAD

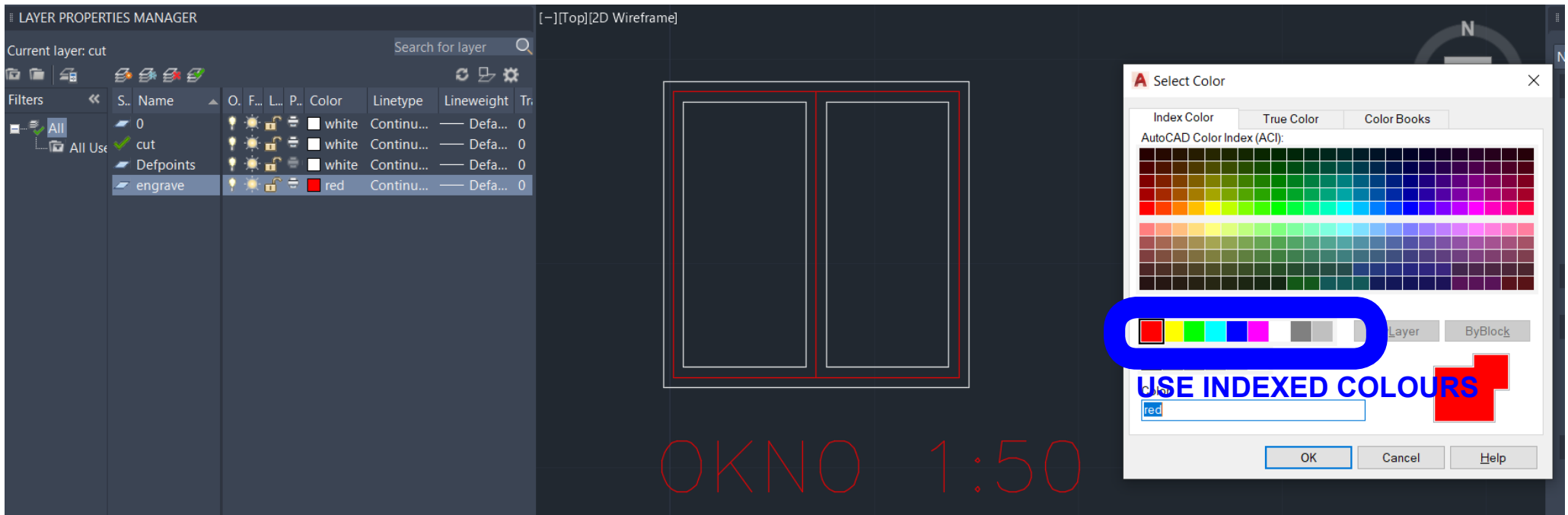

Pri exporte do dxf, v súbore by nemalo byť nič len to čo idete rezať na jeden formát, v dvoch vrstvách - cut a engrave. Vrstva cut by mala byť indexovanou farbou white. Vrstva engrave by mala byť indexovanou farbou red. Všetko by malo byť v mierke modelu, napr. moje okno je v 1:100 a teda má 15 x 15 mm. Ak súbor obsahuje text, napr. rozpisku, odporúčam čiarové písmo romans.shx a rozbiť ho príkazom TXTEXP na polyliny, aby sa čiarý písma neprepálili.

When exporting to dxf, in the file should be only the lines and polylines, which you would like to cut on one board. The lines should be in two layers - cut and engrave. Layer cut should have indexed colour white, Layer engrave should have indexed colour red. Everything should be in the scale of the model, e.g. my window is in the scale 1:100, so currently its size is 15 x 15mm. If the file contains fonts, e.g. table with all info, I recommend to use line font romans.shx and explode it with TXTEXP command to polylines, to not overlay and overburn the lines of the text.

Formát dát - Rhinoceros

Data format - Rhinoceros

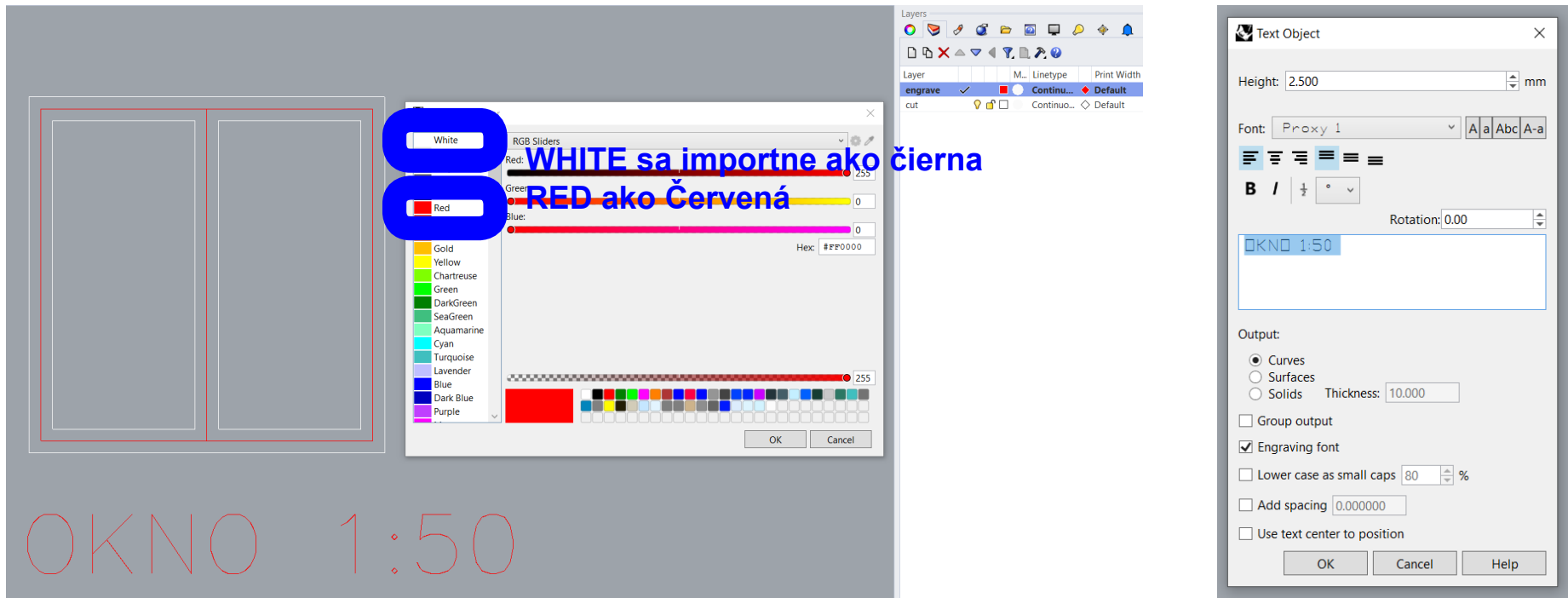

Pri exporte do dxf, v súbore by nemalo byť nič len to čo idete rezať na jeden formát, v dvoch vrstvách - cut a engrave. Pre správny import do laserovacieho programu, vrstva cut by mala byť farbou white. Vrstva engrave by mala byť farbou red. Ak súbor obsahuje text, napr. rozpisu, odporúčam nájsť čiarové písmo určené pre gravírovanie a použiť príkaz textobject, ktorý ho vytvorí ako polyliny. Pozor na prkryv linbiek a možné prepálenie písma.

When exporting to dxf, in the file should be only the lines and polylines, which you would like to cut on one board. The lines should be in two layers - cut and engrave. For correct import to lasering software, layer cut should have colour white. Layer engrave should have colour red. If the file contains fonts, e.g. table with all info, I recommend to find and use some line font for engraving and use command textobject which creates it as polylines. Try to not overlay and overburn the lines of the text.

Formát rezania Cutting format

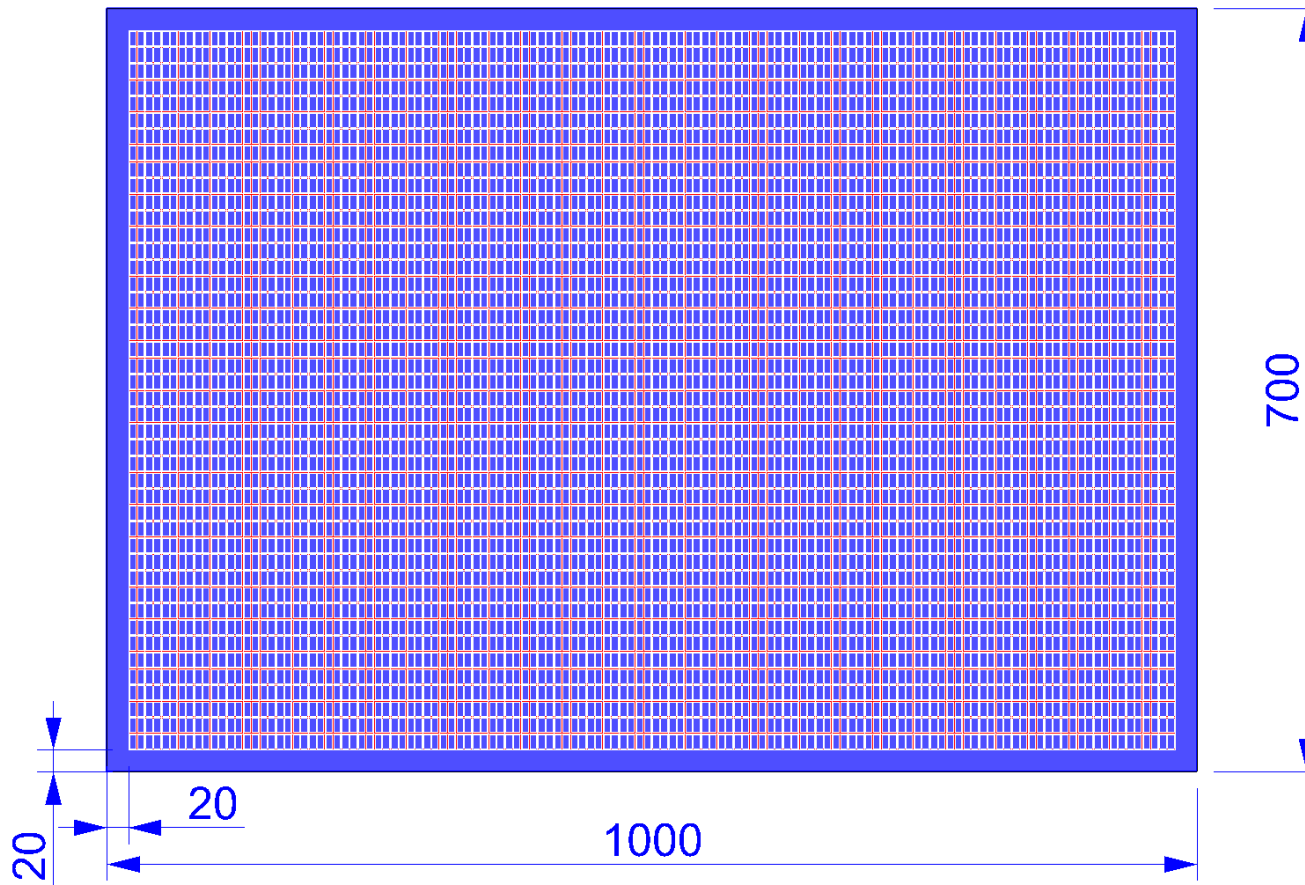

Najčastejšie sa reže z Maslového kartónu, ten sa predáva vo formáte 700x1000 mm. Pri umiestňovaní čiar pre rezanie na formát, nechajte minimálne 20 mm okraj. Formát kartónu by v súbore pre rezanie (.dxf) nemal byť. Na obrázku vyplnený formát kartónu oknami 15x15 mm.

Usually the cardboard is cut. The boards of cardboard are in the format of 700x1000 mm. When you are placing lines for cutting on the format, please leave the 20 mm margins. Lines representing format of the cardboard should not be in the file for lasercutting (.dxf). In the image, format of the cardboard filled with windows 15x15 mm.

Laserové vyrezávanie zapnutie Laser cutting turning on

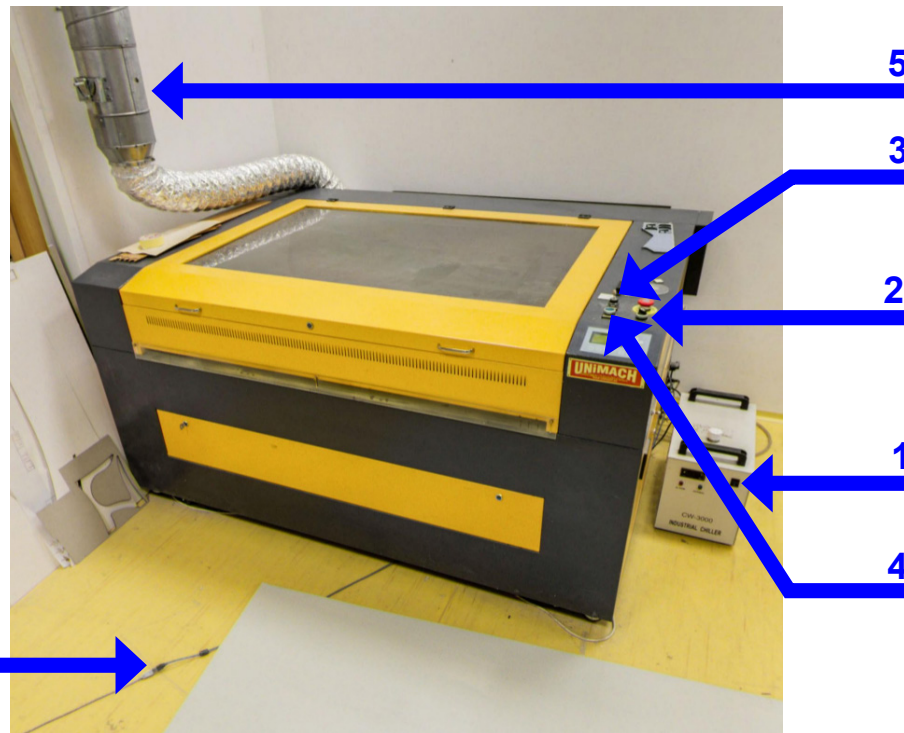

POZOR TU KÁBEL

1 - Zapnite chladenie, 2 - zapnite odvetranie lasera, 3 - Otočte kľúčom, 4 - Zapnite laser, 5 - Zapnite odvetranie miestnosti (Power na dotykovom displayi na stene), 6 - Zapnite PC. Nestúpať na kábel!

Používateľ na PC je **student**
Heslo je **Same0a1**

1 - Turn on cooler, 2 - Turn on ventilation of laser, 3 - Turn the key, 4 - Turn the laser on, 5 - Turn the air ventilation of the room on (Power on the touchscreen display on the wall), 6 - Turn on PC. Do not step on the cable!

User in the PC is **student**
Password is **Same0a1**

Laserové vyrezávanie - vypnutie Laser cutting - turning off

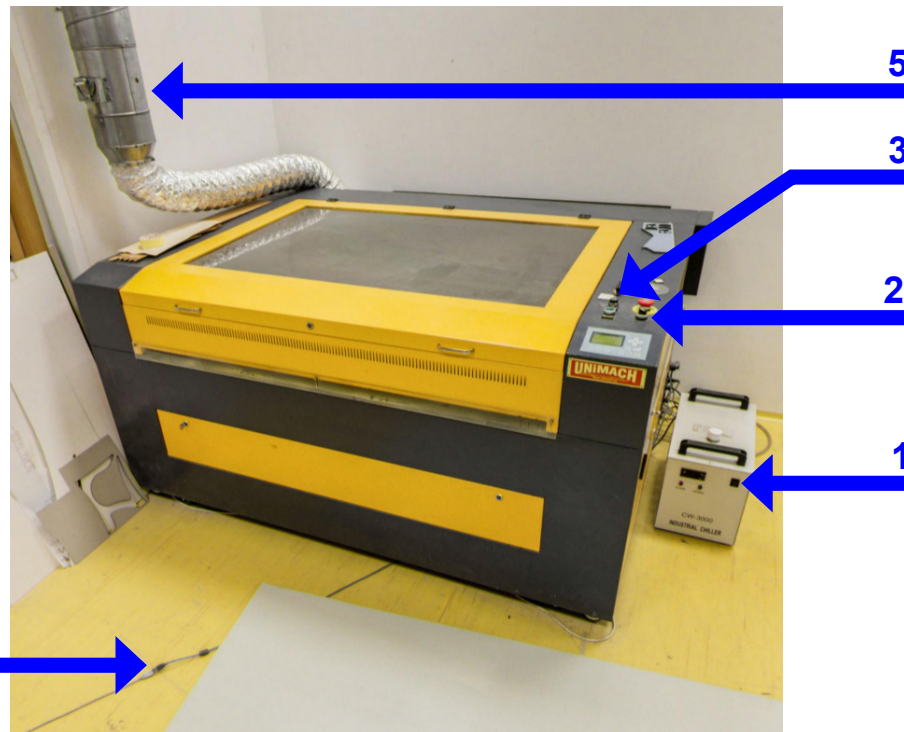

POZOR TU KÁBEL

1 - Vypnite chladienie, 2 - Vypnite odvetranie lasera, 3 - Otočte kľúčom späť, 5 - Vypnite odvetranie miestnosti (Power na dotykovom displayi na stene), 6 - Vypnite PC. Nestúpať na kábel! V miestnosti by mala byť po vypnutí a zhasnutí tma a ticho.

1 - Turn off cooler, 2 - Turn off ventilation of laser, 3 - Turn the key back, 5 - Turn the air ventilation of the room off (Power on the touchscreen display on the wall), 6 - Turn off PC. Do not step on the cable! After turning off the laser machines and the light, there should be darkness and silence in the room.